

# 382-3386 SUMMIT® DUAL FLUSH

**MANSFIELD®**

Elongated Front, Vitreous China, Two-Piece Toilet

## FEATURES

- Dual flush technology with 3" flush tower
- 1.1 Gpf / 1.6 Gpf (4.0 Lpf / 6.0 Lpf) high efficiency water consumption
- Elongated front bowl
- SmartFasten™ 3-bolt tank-to-bowl connection
- PuraClean® easy-to-clean glaze
- Pilot operated anti-siphon fill valve
- 12" rough-in
- Model 33 chrome-plated push button actuator
- 2" glazed trapway
- The Mansfield® limited lifetime warranty
- Available in White, Biscuit and Bone



**MODEL 382-3386**

Toilet seat not included

Available as CTK





ELONGATED



CTK

## COMPONENTS

MODEL #	DESCRIPTION	CODES/STANDARDS
382-3386	Elongated front, two-piece dual flush toilet. Less toilet seat and supply. Specify color.	  
382	Elongated front toilet bowl only. Less toilet seat and supply. Specify color.	
3386	Tank and cover only, with chrome-plated push button actuator. Less supply. Specify color.	
TANK TRIM & REPLACEMENT PARTS		
33	Chrome-plated push button actuator	
2206	Pilot operated fill valve	
308	Dual flush tower	
3386-LID	Tank lid	



**MADE IN  
★ USA**

# 382-3386 SUMMIT® DUAL FLUSH



Elongated Front, Vitreous China, Two-Piece Toilet

## SPECIFICATIONS

MODEL #	DESCRIPTION	CODES/STANDARDS
382-3386	Elongated front, (1.1 gpf/1.6 lpf) two-piece toilet	  

MATERIAL	Vitreous China
WATER PRESSURE RANGE	20 to 80 PSI
FLUSH SYSTEM	Dual flush with 3' flush tower
WATER USAGE	1.1 gpf / 1.6 lpf
WATER SURFACE AREA	9' X 10'
ROUGH-IN	12'
MAP RATING	800 grams

TRAP DIAMETER	2'
TRAP SEAL	2-1/4'
SHIPPING WEIGHT	Model 382 - 50 lbs. (22.6 kg) Model 3386 - 38 lbs. (17.2 kg)
WARRANTY	Vitreous China - Limited Lifetime Tank Trim - Limited One Year

## TECHNICAL INFORMATION

**Note:** these dimensions are nominal and subject to change without notice.

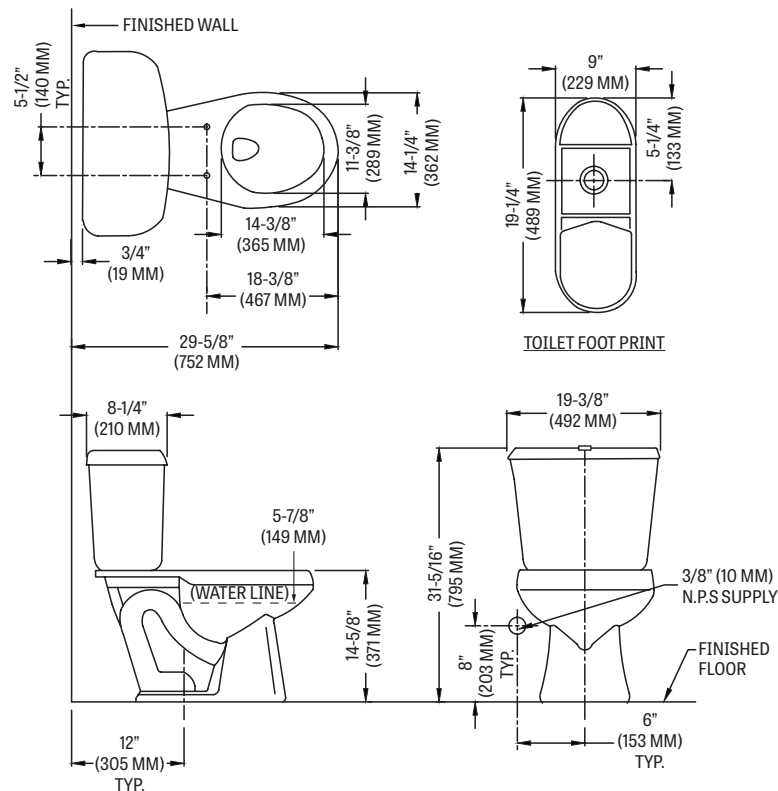

Fixture performance and specifications meet or exceed ASME A112.19.2/CSA B45.1 standards, and other state and local codes.

